

The Winning Force

DURMA

SBT SERIES
SWING BEAM SHEAR



- Perfect Cutting
- Hi-Speed
- Heavy Duty
- Accurate
- Efficient



DURMA The Winning Force



As a total supplier for sheet metal manufacturing with almost 60 years of experience, Durma understands and recognizes the challenges, requirements and expectations of the industry. We strive to satisfy the ever higher demands of our customers by continuously improving our products and processes while researching and implementing the latest technologies.

In our three production plants with a total of 150.000 m², we dedicate 1,000 employees to delivering high quality manufacturing solutions at the best performance-to-price ratio in the market.

From the innovations developed at our Research & Development Center to the technical support given by our worldwide distributors, we all have one common mission: to be your preferred partner.

Present Durmazlar machines with **DURMA** name to the world.



1
High technology,
modern production
lines

2
Top quality
components

3
High quality
machines designed
in R&D Centre

The Winning Force

Rigid body structure and perfect cutting

Unique design and rigid body enable SBT series to provide perfect cutting quality and low cost solutions.

Advance Your Standards

Precision and high quality cuttings

High technology standards, design and user-friendly interface SBT provides perfection with high standard safety, efficient solutions that strengthen your skills and add value to your company.

We have reduced the cutting angle to achieve straight precision and minimum twist tolerance.

Easy to Use

Economic

Efficient

Faster

Reliable Brand



Why *DURMA* Shears

- Fast and quality cuttings
- Robust body structure
- High precision and repeatability
- Low maintenance cost
- Hi-tech perfect equipments
- Boost your business
- Reliable Brand

Gain More Power

High performance, advanced technology and economic solution

DURMA Shears have been manufactured since 1956 and have been installed and working in a wide variety of sheet metal cutting operations for many industries.

Years of experience has helped us develop durable, low distortion and precise cutting machines.



General Specifications

- Robust design & powerful body for perfect cutting
- Hardened and ground blades for long life and precise
- Proved and rigid design with swing beam top table
- Minimum deformation and optimum cutting quality with best cutting angle
- CE standards security
- The combination of economic and perfect cutting performance
- CNC controlled gap adjustment and cutting angle
- User friendly CNC touch screen control unit
- Provide flexible use for narrow or wide, thin or thick sheet metal cutting.
- Automatic swing up back gauge for more comfortable use
- Sheet support arms
- Balls tranfered table and T-slot front feedings arm helps prices cuttings
- Table with balls and feeding plates

Strong Back Gauge System

- Precise
- Robust
- Min. Deformation

- Fast and high accuracy
- Reliable movement
- Adjustment from each point
- Resistance to crash
- Maintenance free



Why *DURMA* Back Gauge?

One of the most important factor for cutting capacity is the design of back gauge and stability.

Quality cutting is possible with perfect product, stability and precision back gauge.

The high speed **ballscrew** back gauge system movement is also supported with **linear guides**, which helps the back gauge achieve long life, greater sensitivity and strengthens against any collisions.



Ballscrew back gauge

SBT Series General Features

With choice of standards and optional equipment SBT boost your business by offering proper solutions for your needs. With the hi-tech features like high efficiency, precision, and high performance criteria SBT has proved that it is user friendly and the best of this sector.



Flip-up Finger Guard
Ball Transfer Table
Hydraulic Holddowns



Adjustable Angle Stop 0-180°



Light Curtains For Finger Protection



Blade Gap Adjustment



Thin Sheet Support System

Sheet Support Systems

- Better and fast cutting
- Easy and secure usage
- High precision and repeatability



Pneumatic Thin Sheet Support System

DURMA I

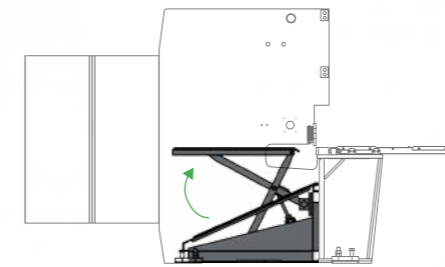

Step 1

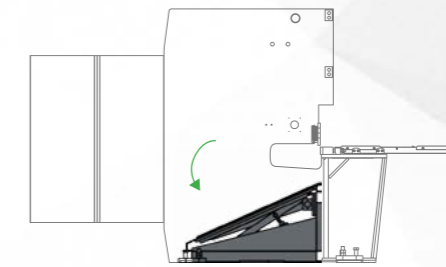

Step 2

Pneumatic Thin Sheet Support System

DURMA IV

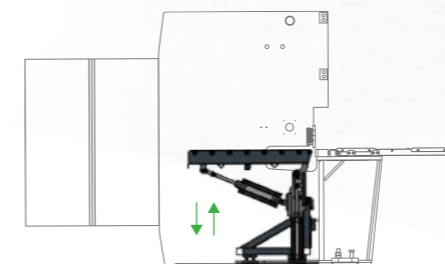

Step 1

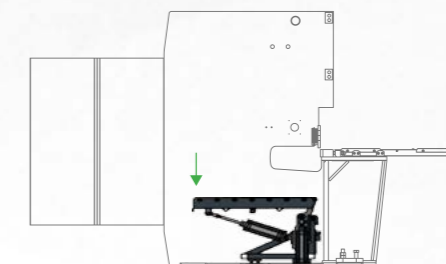

Step 2

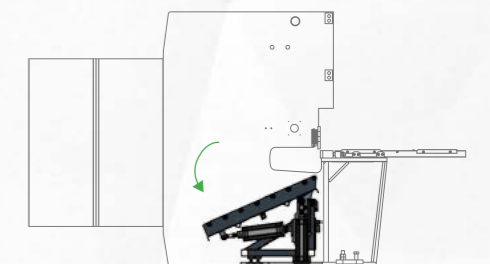

Step 3

SBT Series Technical Details

SBT Series	Cutting Length	Cutting Capacity		Throat Depth	Stroke per min.	Cutting Angle	Holddowns	Holddown Force	Back Gauge Range	Back Gauge Force
		MS (450 N/mm ²)	SS (700 N/mm ²)							
		mm	mm							
A			D							
3006	3100	6	4	50	15	1° 30'	16	14	1000	0,75
3010	3100	10	6	50	13	1° 30'	16	22	1000	0,75
3013	3100	13	8	50	13	1° 45'	16	37	1000	0,75
3016	3100	16	10	350	10	2°	14	61	1000	0,75
3020	3100	20	13	350	6	2°	14	77	1000	0,75
4006	4100	6	4	50	12	1° 30'	20	17	1000	0,75

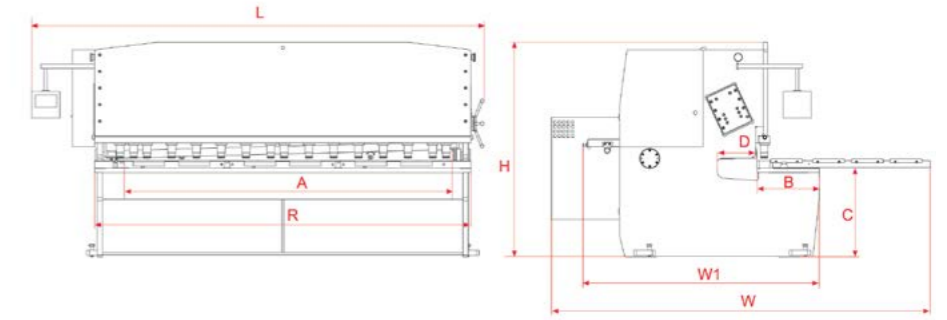

Back Gauge Speed	Motor Power	Oil Capacity	Front Armas	Tabla Height	Table Width	Table Length	Length	Width	Total Width	Height	Weight
mm/sec.	kW	lt	Unit	mm	mm	mm	mm	mm	mm	mm	~kg
				C	B	R	L	W1	W	H	
200	15	200	2	865	500	3515	4110	2200	3700	2100	7650
200	22	200	2	865	580	3515	4200	2250	3600	2100	9300
200	30	330	2	845	600	3550	4280	2300	3600	2350	12500
200	37	410	2	818	550	3580	4550	2250	3825	2250	15000
200	45	450	2	886	570	3670	4450	2260	3400	2450	21700
200	15	200	3	865	580	4510	5230	2300	3600	2150	11750
200	30	330	3	818	550	4520	5350	2250	3650	2250	16300

Standard & Optional Equipment

Standard Equipment





- Heavy duty St 44 steel construction & stress relieved frame
- User friendly CNC Touch screen control unit D-Touch 7
- Easy blade gap adjustment
- Ball integrated front tables
- Ballscrew back gauge, 1000 mm & automatic swing-up
- Squaring arm with scale & T-Slot & tilting stop
- Support arms T-Slot & Tilting stop
- Illumination & shadow line 1 mt flip-up finger guards
- Automatically pressure adjusted solid holddowns
- Top blades with 2 sides and Bottom blades with 4 sides
- Foot pedal
- High performance hydraulics & electronics components
- Automatic Swing-up back gauge
- CE-Norm

Optional equipment

- Motorized blade gap adjustment
- Laser cutting line
- Light curtains for finger protection
- Pneumatic thin sheet support *DURMA I*
- Pneumatic thin sheet support *DURMA IV*
- Special throat depth
- Backgauge 1250 mm.
- Add. support arms
- Special blades
- Oil coolant
- Oil Heater
- Adjustable angle stop 0-180°
- Control panel on opposite position
- Temperature measurement
- Overseas special packaging

D-Touch 7 Control Unit



-  Fast data entry
-  Easy connection USB port
-  Ethernet Rj-45 10/100M
-  Easy programming

Cuttings are easier with D-Touch 7

With easy to use interface D-Touch 7 enables perfect cutting in seconds by endless programming and material entrance feature.

- Wide, colored, touch-screen (LCD 7" 800x480)
- Quick data entry
- Easy connection
- USB input
- Ethernet: RJ-45 10/100M
- Windows CE Unlimited program and steps
- Unlimited material type

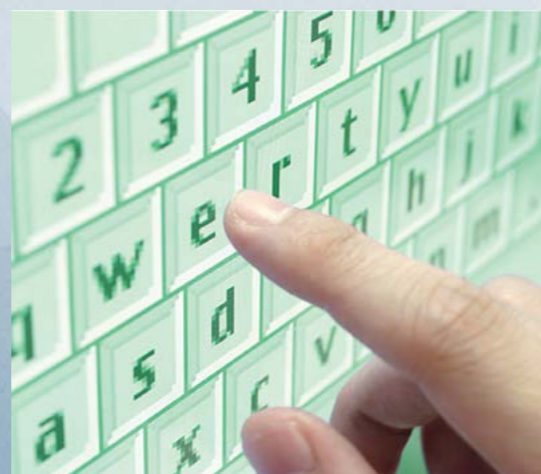

Fast on Service and Spare Parts

DURMA provides the best level of service and spare parts with qualified personnel and spare parts in stock. Our experienced and professional service personnel are always ready at your service. Our professional training and application enriched courses will give you an advantage to use our machinery.



Consultancy



Spare Parts



R&D Center



After Sales Service

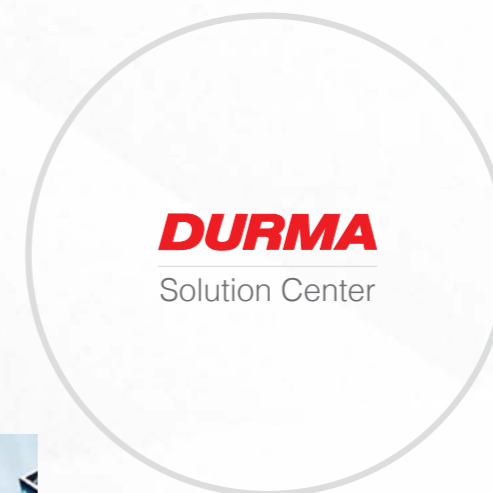

Service Agreements



Software



Training



Flexible Solution



FIBER LASER



PUNCH



PRESS BRAKE



VARIABLE RAKE SHEAR



PLASMA



L ANGLE PROCESSING CENTER



ROLL BENDING



PROFILE BENDING



IRON WORKER



POWER OPERATED SHEAR



BANDSAW



CORNER NOTCHER

DURMA

Today, Tomorrow and Forever with You...

SBT SERIES
SWING BEAM SHEAR

Durmazlar Makina San. Tic. A.Ş. has right to change catalogue values and machine technical details without notice.

Durmazlar Makina San. ve Tic. A.Ş.
OSB 75. Yıl Bulvarı Nilüfer-Bursa / Türkiye
P: +90 224 219 18 00
F: +90 224 242 75 80
info@durmazlar.com.tr

www.durmazlar.com.tr

